



AQUASNAP™



Model shown is with low-noise option

30RB 039-160

Nominal cooling capacity 40-160 kW

The new generation of Aquasnap Puron liquid chillers was designed for commercial (air conditioning of offices, hotels etc.) or industrial (low-temperature process chillers etc.) applications.

The new Aquasnap Puron integrates the latest technological innovations:

- ozone-friendly refrigerant R410A
- scroll compressors
- low-noise fans made of a composite material
- auto-adaptive microprocessor control
- electronic expansion valve
- variable-speed pump (option)

The Aquasnap can be equipped with a hydronic module integrated into the chiller chassis, limiting the installation to straightforward operations like connection of the power supply and the chilled water supply and return piping.

Features

Quiet operation

- Compressors
 - Low-noise scroll compressors with low vibration level
 - The compressor assembly is installed on an independent chassis and supported by anti-vibration mountings
 - Dynamic suction and discharge piping support, minimising vibration transmission (Carrier patent)
- Condenser section
 - Vertical condenser coils
 - Protection grilles on anti-vibration mountings to protect the heat exchanger against possible shocks.
 - Low-noise latest-generation Flying Bird IV fans, made of a composite material (Carrier patent) are now even quieter and do not generate intrusive low-frequency noise
 - Rigid fan installation for reduced start-up noise (Carrier patent)

Easy and fast installation

- Integrated hydronic module (option)
 - Centrifugal low or high-pressure water pump (as required), based on the pressure loss of the hydronic installation

Hydronic module



- Single or dual pump (as required) with operating time balancing and automatic changeover to the back-up pump if a fault develops
- Water filter protecting the water pump against circulating debris
- Pressure measurement, using two pressure transducers and allowing indication of water flow rate, water pressure and lack of water.
- High-capacity membrane expansion tank ensures pressurisation of the water circuit
- Overpressure valve, set to 4 bar
- Speed variator on the pumps (option) to ensure the correct flow rate, based on the system requirements
- Thermal insulation and frost protection down to -20°C, using an electric resistance heater (see table of options)
- Physical features
 - The unit has a small footprint and a low height (1330 mm) allowing it to blend in with any architectural styles.
 - The unit is enclosed by easily removable panels, covering all components (except condensers and fans).
- Simplified electrical connections
 - A single power supply point without neutral
 - Main disconnect switch with high trip capacity
 - Transformer for safe 24 V control circuit supply included
- Fast commissioning
 - Systematic factory operation test before shipment
 - Quick-test function for step-by-step verification of the instruments, electrical components and motors

Economical operation

The variable-speed pump (option) ensures economical operation

The control algorithm adjusts the water flow rate based on the actual system requirements and obsoletes the need for the control valve at the chiller outlet.

- Increased energy efficiency at part load
 - The refrigerant circuit includes several compressors connected in parallel. At part load, around 99% of the operating time, only the compressors that are absolutely necessary operate. At these conditions the compressors operating are more energy efficient, as they use the total condenser and evaporator capacity.
 - The electronic expansion device (EXV) allows operation at a lower condensing pressure (EER optimisation).
 - Dynamic superheat management for better utilisation of the evaporator heat exchange surface.

- Reduced maintenance costs
 - Maintenance-free scroll compressors
 - Fast diagnosis of possible incidents and their history via the Pro-Dialog+ control
 - R410A refrigerant is easier to use than other refrigerant blends

Environmental care

- Ozone-friendly R410A refrigerant
 - Chlorine-free refrigerant of the HFC group with zero ozone depletion potential
 - High-density refrigerant, therefore less refrigerant required
 - Very efficient - gives an increased energy efficiency ratio (EER)
- Leak-tight refrigerant circuit
 - Brazed refrigerant connections for increased leak-tightness
 - Reduction of leaks due to reduced vibration levels and elimination of capillary tubes (TXVs)
 - Verification of pressure transducers and temperature sensors without transferring refrigerant charge

Partial view of the hydronic circuit



Superior reliability

- State-of-the-art concept
 - Cooperation with specialist laboratories and use of limit simulation tools (finite element calculations) for the design of the critical components, e.g. motor supports, suction/discharge piping etc.
- Auto-adaptive control
 - Control algorithm prevents excessive compressor cycling and permits reduction of the water quantity in the hydronic circuit (Carrier patent)
 - Hydronic module with integrated pressure transducers allowing measurement of the water pressure at two points, as well as measurement of the water flow rate and detection of lack of water and pressure. This considerably reduces the risk of problems such as frost accumulation on the evaporator.
 - Automatic compressor unloading in case of abnormally high condensing pressure. If an anomaly occurs (e.g. fouled condenser coil, fan failure) Aquasnap continues to operate, but at reduced capacity.
- Exceptional endurance tests
 - Corrosion resistance tests in salt mist in the laboratory
 - Accelerated ageing test on components that are submitted to continuous operation: compressor piping, fan supports
 - Transport simulation test in the laboratory on a vibrating table.

Pro-Dialog+ control

Pro-Dialog+ combines intelligence with operating simplicity. The control constantly monitors all machine parameters and precisely manages the operation of compressors, expansion devices, fans and of the evaporator water pump for optimum energy efficiency.

Pro-Dialog+ interface

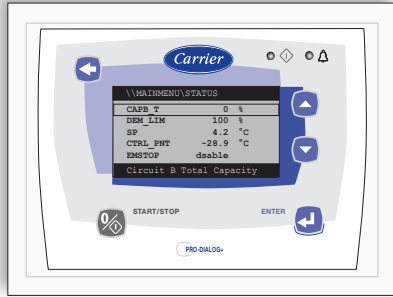

- Energy management
 - Seven-day internal time schedule clock: permits chiller on/off control and operation at a second set point
 - Set point reset based on the outside air temperature or the return water temperature or on the water heat exchanger delta T
 - Master/slave control of two chillers operating in parallel with operating time equalisation and automatic change-over in case of a unit fault (accessory).
 - Change-over based on the outside air temperature
- Integrated features
 - Night mode: capacity and fan speed limitation for reduced noise level
 - With hydronic module: water pressure display and water flow rate calculation
- Ease-of-use
 - The new backlit LCD interface includes a manual control potentiometer to ensure legibility under any lighting conditions.
 - The information is displayed clearly in English, French, German, Italian and Spanish (for other languages please consult Carrier)
 - The Pro-Dialog+ navigation uses intuitive tree-structure menus, similar to the Internet navigators. They are user-friendly and permit quick access to the principal operating parameters: number of compressors operating, suction/discharge pressure, compressor operating hours, set point, air temperature, entering/leaving water temperature

Remote operating mode with volt-free contacts (standard)

A simple two-wire communication bus between the RS485 port of the Aquasnap and the Carrier Comfort Network offers multiple remote control, monitoring and diagnostic possibilities. Carrier offers a vast choice of control products, specially designed to control, manage and supervise the operation of an air conditioning system. Please consult your Carrier representative for more information on these products.

- Start/stop: opening of this contact will shut down the unit
- Dual set point: closing of this contact activates a second set point (example: unoccupied mode)
- Water pump 1 and 2 control*: these outputs control the contactors of one or two evaporator water pumps
- Alert indication: this volt-free contact indicates the presence of a minor fault
- Alarm indication: this volt-free contact indicates the presence of a major fault that has led to the shut-down of one or two refrigerant circuits
- Demand limit 1 and 2: closing of these contacts limits the maximum chiller capacity to three predefined values
- User safety: this contact can be used for any customer safety loop, closing of the contact generates a specific alarm
- Out of service: this signal indicates that the chiller is completely out of service
- Chiller capacity: this analogue output (0-10 V) gives an immediate indication of the chiller capacity
- Compressor operation: this contact signals that one or several compressors are in operation

* contacts already supplied with the hydronic module option

Remote interface (accessory)

This interface allows access to the same menus as the unit interface and can be installed up to 300 m away. This accessory includes a box that can be mounted inside the building. The power supply is provided via a 220 V/24V transformer supplied.

Flying Bird IV fan

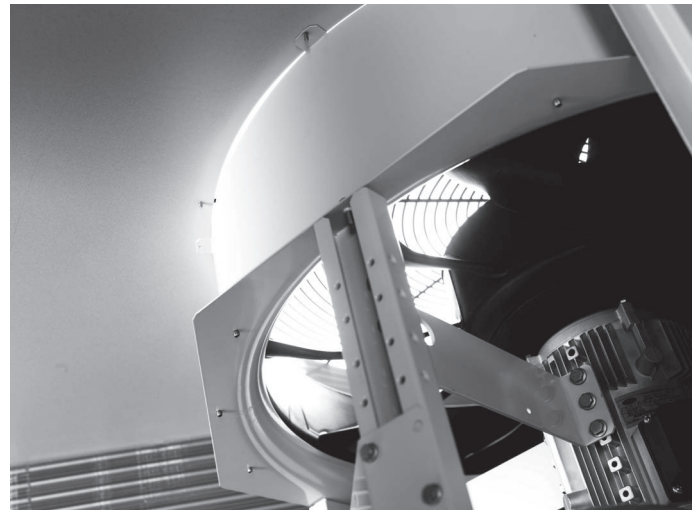

Options and accessories

Options	No.	Description	Advantages	Use
Condenser with anti-corrosion post-treatment	2B	Coils with factory-applied Blygold Polual treatment	Improved corrosion resistance, recommended for urban, industrial and rural environments	30RBS 039-160
Condenser with pre-treated fins	3A	Fins made of pre-treated aluminium (polyurethane or epoxy)	Improved corrosion resistance, recommended for marine environments	30RBS 039-160
Very low noise level	15LS	Acoustic compressor enclosure and low-speed fans (12 r/s or 720 rpm)	Noise emission reduction	30RBS 050-160
Soft starter	25	Electronic compressor starter	Reduced compressor start-up current	30RBS 039-080
Winter operation	28	Fan speed control via frequency converter	Stable unit operation when the air temperature is between -10°C and -20°C	30RBS 039-160
Frost protection down to -20°C	42	Electric heater on the hydronic module	Hydronic module frost protection at low outside temperature	30RBS 039-160
High-pressure single-pump hydronic module	116B	See hydronic module chapter	Easy and fast installation	30RBS 039-160
High-pressure dual-pump hydronic module	116C	See hydronic module chapter	Easy and fast installation, operating safety	30RBS 039-160
Low-pressure single-pump hydronic module	116F	See hydronic module chapter	Easy and fast installation	30RBS 039-160
Low-pressure dual-pump hydronic module	116G	See hydronic module chapter	Easy and fast installation, operating safety	30RBS 039-160
High-pressure variable-speed single-pump hydronic module	116J	See hydronic module chapter	Easy and fast installation, power consumption reduction of the water circulation pump	30RBS 039-160
High-pressure variable-speed dual-pump hydronic module	116K	See hydronic module chapter	Easy and fast installation, operating safety, power consumption reduction of the water circulation pump	30RBS 039-160
JBus gateway	148B	Two-directional communications board, complies with JBus protocol	Easy connection by communication bus to a building management system	30RBS 039-160
Bacnet gateway	148C	Two-directional communications board, complies with Bacnet protocol	Easy connection by communication bus to a building management system	30RBS 039-160
LonTalk gateway	148D	Two-directional communications board, complies with LonTalk protocol	Easy connection by communication bus to a building management system	30RBS 039-160
Accessories	-	Description	Advantages	Use
Twinning	-	Unit equipped with an additional field-installed leaving water temperature sensor, allowing master/slave operation of two chillers connected in parallel	Operation of two chillers connected in parallel with operating time equalisation	30RBS 039-160
Remote interface	-	Remotely installed user interface (via communication bus).	Remote chiller control up to 300 m	30RBS 039-160

* Winter operation option: This option allows operation of the unit down to -20°C outside temperature due to the optimised control of the condensing temperature. One fan is equipped with a frequency converter.

Physical data

30RBS		039	045	050	060	070	080	090	100	120	140	160
Nominal cooling capacity, standard unit*	kW	39.3	44.6	51.9	58.4	66.7	78.6	89.4	99.9	117.0	134.3	157.1
Power input	kW	13.7	16.1	18.9	21.2	24.4	29.0	31.8	35.9	43.2	49.1	57.9
EER	kW/kW	2.88	2.77	2.75	2.76	2.74	2.71	2.81	2.78	2.71	2.74	2.71
Eurovent class, cooling	C	C	C	C	C	C	C	C	C	C	C	C
ESEER part-load performance	kW/kW	4.04	4.09	4.07	4.06	4.04	4.04	4.22	4.20	4.12	4.14	4.13
Nominal cooling capacity, standard unit**	kW	52.6	59.2	72.7	80.2	81.8	107.0	120.1	133.1	154.6	184.2	218.2
Power input	kW	15	17	20	23	26	30	35	40	48	52	62
EER	kW/kW	3.4	3.3	3.4	3.4	3.1	3.3	3.3	3.2	3.1	3.4	3.4
Noise levels												
Sound power level Lw(A) ***	dB(A)	80	81	81	81	87	87	84	84	84	90	90
Sound pressure level at 10 m Lp(A)****	dB(A)	49	49	49	49	55	55	52	52	52	58	58
Operating weight†												
Standard unit without hydronic module	kg	458	466	489	515	502	533	835	845	876	982	1046
Standard unit with hydronic module												
Single high-pressure pump	kg	488	496	519	545	531	562	867	877	912	1021	1085
Dual high-pressure pump	kg	514	522	545	571	557	588	912	922	960	1058	1122
Refrigerant												
		R-410A										
Circuit A	kg	8.5	9.0	12.5	15.0	12.5	15.5	19.0	20.0	25.0	12.5	16.0
Circuit B	kg	-	-	-	-	-	-	-	-	-	12.5	16.0
Compressors		Hermetic scroll compressors, 48.3 r/s										
Circuit A		2	2	2	2	2	2	3	3	3	2	2
Circuit B		-	-	-	-	-	-	-	-	-	2	2
Number of capacity stages		2	2	2	2	2	2	3	3	3	4	4
Minimum capacity	%	50	50	50	50	50	50	33	33	33	25	25
Control		Pro-Dialog +										
Condensers		Grooved copper tubes and aluminium fins										
Fans		Axial Flying Bird IV with rotating shroud										
Quantity		1	1	1	1	1	1	2	2	2	2	2
Total air flow (at high speed)	l/s	3800	3800	3800	3800	5300	5300	7600	7600	7600	10600	10600
Speed	r/s	12	12	12	12	12	16	12	12	12	16	16
Evaporator		Direct expansion, plate heat exchanger										
Water volume	l	2.6	3.0	3.3	4.0	4.8	5.6	8.7	9.9	11.3	12.4	14.7
Max. water-side operating pressure without hydronic module	kPa	1000	1000	1000	1000	1000	1000	1000	1000	1000	1000	1000
Max. water-side operating pressure with hydronic module	kPa	400	400	400	400	400	400	400	400	400	400	400
Hydronic module (option)		Pump, Victaulic screen filter, safety valve, expansion tank, purge valves (water and air), pressure sensors										
Single or dual pump (as selected)												
Expansion tank	l	12	12	12	12	12	12	35	35	35	35	35
Expansion tank pressure††	bar	1	1	1	1	1	1	1.5	1.5	1.5	1.5	1.5
Max. water-side operating pressure with hydronic module	kPa	400	400	400	400	400	400	400	400	400	400	400
Water connections with/without hydronic module		Victaulic										
Diameter	in	2	2	2	2	2	2	2	2	2	2	2
Outside diameter	mm	60.3	60.3	60.3	60.3	60.3	60.3	60.3	60.3	60.3	60.3	60.3

* Standard Eurovent LCP/A/P/C/AC conditions in cooling mode: evaporator entering/leaving water temperature 12°C/7°C, outside air temperature 35°C, evaporator fouling factor 0.18 x 10⁻⁴ (m² K)/W

** Standard Eurovent LCP/A/P/C/CHF conditions in cooling mode: evaporator entering/leaving water temperature 23°C/18°C, outside air temperature 35°C, evaporator fouling factor 0.18 x 10⁻⁴ (m² K)/W

*** In accordance with ISO 9614-1 (10⁻¹² W)

**** For information, calculated from the sound power level Lw(A)

† Weight shown is a guideline only. To find out the unit refrigerant charge, please refer to the unit nameplate.

†† When delivered, the pre-inflation of the tank keeps the plated membrane in the upper part of the tank. To permit changing the water volume, change the inflation pressure to a pressure that is close to the static head of the system (see below), fill the system with water (purging the air) to a pressure value that is 10 to 20 kPa higher than the pressure in the tank.

Static head, m/Pressure, bar/Pressure, kPa 5 - 0,5 - 50/10 - 1 - 100/15 - 1,5 - 150/20 - 2 - 200/25 - 2,5 - 250/30 - 3 - 300/35 - 3,5 - 350

Sound spectrum

30RBS – Standard units

	Octave bands, Hz						Sound power levels		
	125	250	500	1k	2k	4k			
039	dB	77.0	78.9	78.5	75.1	71.9	67.2	dB(A)	80
045	dB	77.0	79.0	78.7	76.0	72.8	67.3	dB(A)	81
050	dB	77.0	79.0	78.9	76.0	72.4	67.8	dB(A)	81
060	dB	77.0	78.9	78.7	76.0	73.7	68.8	dB(A)	81
070	dB	81.3	83.5	84.4	82.9	76.9	72.6	dB(A)	87
080	dB	81.3	83.5	84.5	82.9	77.2	71.1	dB(A)	87
090	dB	80.0	81.9	81.6	78.7	75.9	70.7	dB(A)	84
100	dB	80.0	81.9	81.7	78.8	76.1	73.7	dB(A)	84
120	dB	80.0	81.9	81.8	78.9	76.8	71.4	dB(A)	84
140	dB	84.3	86.5	87.4	85.9	79.9	75.6	dB(A)	90
160	dB	84.3	86.5	87.5	85.9	80.2	74.1	dB(A)	90

30RBS - Units with low sound levels

	Octave bands, Hz						Sound power levels		
	125	250	500	1k	2k	4k			
039	dB	77.0	78.9	78.4	74.5	69.7	62.6	dB(A)	79
045	dB	77.0	78.9	78.5	74.6	70.0	62.7	dB(A)	80
050	dB	77.0	78.9	78.5	74.6	69.9	63.1	dB(A)	80
060	dB	77.0	78.9	78.4	74.7	70.4	63.8	dB(A)	80
070	dB	77.0	78.9	78.5	74.7	70.5	66.2	dB(A)	80
080	dB	77.0	78.9	78.5	74.7	70.9	64.3	dB(A)	80
090	dB	80.0	81.9	81.4	77.6	73.1	66.0	dB(A)	83
100	dB	80.0	81.9	81.5	77.6	73.2	68.3	dB(A)	83
120	dB	80.0	81.9	81.5	77.6	73.5	66.5	dB(A)	83
140	dB	80.0	81.9	81.5	77.7	73.5	69.2	dB(A)	83
160	dB	80.0	81.9	81.5	77.7	73.9	67.3	dB(A)	83

Electrical data

30RBS without hydronic module		039	045	050	060	070	080	090	100	120	140	160
Power circuit												
Nominal power supply	V-ph-Hz	400-3-50										
Voltage range	V	360-440										
Control circuit supply		24 V via internal transformer										
Maximum start-up current (Un)*												
Standard unit	A	112.7	130.9	141.0	143.4	170.4	209.4	168.8	195.8	239.8	226.2	275.2
Unit with electronic starter option	A	74.7	86.5	93.8	96.2	114.4	139.8	-	-	-	-	-
Unit power factor at maximum capacity**												
		0.83	0.81	0.81	0.83	0.81	0.78	0.83	0.81	0.79	0.81	0.78
Maximum operating power input**												
	kW	18.8	20.8	24.4	27.8	31.2	35.8	42.2	45.5	52.4	62.3	71.5
Nominal unit operating current draw***												
	A	25.7	30.6	34.9	38.3	45.6	55.8	57.8	67.1	82.7	91.2	112.2
Maximum operating current draw (Un)****												
	A	32.9	37.3	43.5	48.3	55.8	65.8	73.7	81.2	96.2	111.6	131.6
Maximum operating current draw (Un-10%)†												
	A	38.1	49.1	51.3	57.9	74.6	81.2	88.3	108.1	118.0	149.2	162.4
Customer-side unit power reserve												
	kW	Customer reserve at the 24 V control power circuit										
Short-circuit stability and protection												
		See table below										

* Maximum instantaneous start-up current at operating limit values (maximum operating current of the smallest compressor(s) + fan current + locked rotor current of the largest compressor).
 ** Power input, compressors and fans, at the unit operating limits (saturated suction temperature 10°C, saturated condensing temperature 65°C) and nominal voltage of 400 V (data given on the unit nameplate).

*** Standardised Eurovent conditions: evaporator entering/leaving water temperature 12°C/7°C, outside air temperature 35°C.

**** Maximum unit operating current at maximum unit power input and 400 V (values given on the unit nameplate).

† Maximum unit operating current at maximum unit power input and 360 V.

Short-circuit stability current (TN system*) - standard unit (with main disconnect without fuse)

30RBS		039	045	050	060	070	080	090	100	120	140	160
Value without upstream protection												
Short-term current at 1s - I _{cw} - kA rms		3.36	3.36	3.36	3.36	3.36	3.36	5.62	5.62	5.62	5.62	5.62
Admissible peak current - I _{pk} - kA pk		20	20	20	20	20	15	20	20	15	20	15
Value with upstream protection by circuit breaker												
Conditional short-circuit current I _{cc} - kA rms		40	40	40	40	40	40	40	40	40	30	30
Schneider circuit breaker - Compact series		NS100H	NS100H	NS100H	NS100H	NS100H	NS100H	NS100H	NS100H	NS160H	NS160H	NS250H
Reference No.**		29670	29670	29670	29670	29670	29670	29670	29670	30670	30670	31671

* Earthing system type

** If another current limitation protection system is used, its time-current and thermal constraint (I²t) trip characteristics must be at least equivalent to those of the recommended Schneider circuit breaker. Contact your nearest Carrier office.

The short-circuit stability current values above are in accordance with the TN system.

Electrical data and operating conditions notes:

- 30RB 039-160 units have a single power connection point located immediately upstream of the main disconnect switch.
- The control box includes the following standard features:
 - a main disconnect switch,
 - starter and motor protection devices for each compressor, the fans and the pump,
 - the control devices.
- Field connections:
All connections to the system and the electrical installations must be in full accordance with all applicable local codes.
- The Carrier 30RB units are designed and built to ensure conformance with these codes. The recommendations of European standard EN 60204-1 (machine safety - electrical machine components - part 1: general regulations - corresponds to IEC 60204-1) are specifically taken into account, when designing the electrical equipment.

NOTES:

- Generally the recommendations of IEC 60364 are accepted as compliance with the requirements of the installation directives. Conformance with EN 60204-1 is the best means of ensuring compliance with the Machines Directive § 1.5.1.
- Annex B of EN 60204-1 describes the electrical characteristics used for the operation of the machines.

- The operating environment for the 30RB units is specified below:
 1. Environment* - Environment as classified in EN 60721 (corresponds to IEC 60721):
 - outdoor installation*
 - ambient temperature range: -20°C to +48°C, class 4K4H
 - altitude: ≤ 2000 m
 - presence of hard solids, class 4S2 (no significant dust present)
 - presence of corrosive and polluting substances, class 4C2 (negligible)
 2. Power supply frequency variation: ± 2 Hz.
 3. The neutral (N) conductor must not be connected directly to the unit (if necessary use a transformer).
 4. Overcurrent protection of the power supply conductors is not provided with the unit.
 5. The factory-installed disconnect switch is of a type suitable for power interruption in accordance with EN 60947.
 6. The units are designed for connection to TN networks (IEC 60364). For IT networks the earth connection must not be at the network earth. Provide a local earth, consult competent local organisations to complete the electrical installation.

Caution: If particular aspects of an actual installation do not conform to the conditions described above, or if there are other conditions which should be considered, always contact your local Carrier representative.

* The required protection level for this class is IP43BW (according to reference document IEC 60529). All 30RB units are protected to IP44CW and fulfil this protection condition.

Operating limits

Evaporator water flow rate

30RBS	Minimum flow rate, l/s	Maximum flow rate, l/s*		Maximum flow rate, l/s**
		Low pressure	High pressure	
039	0.9	2.9	3.4	3.0
045	0.9	3.2	3.8	3.4
050	0.9	3.3	4.0	3.7
060	0.9	3.7	4.4	4.2
070	1.0	4.1	5.0	5.0
080	1.2	4.4	5.2	5.5
090	1.3	5.1	6.2	6.8
100	1.5	6.3	6.5	7.7
120	1.7	6.5	8.0	8.5
140	2.0	7.9	8.7	10.6
160	2.3	8.2	8.9	11.2

* Maximum flow rate at an available pressure of 20 kPa (unit with low-pressure hydronic module) or 50 kPa (high-pressure module).

** Maximum flow rate at a pressure drop of 100 kPa in the plate heat exchanger (unit without hydronic module).

Note: Maximum flow rate with single pump is 2 to 4% higher, depending on the size.

Operating range

	Minimum	Maximum
Evaporator		
Entering water temperature at start-up	°C 7.5*	30
Leaving water temperature during operation	°C 5**	20
Entering/leaving water temperature difference	K 3	10
Condenser		
Entering air temperature***	°C -10	48

Note: Do not exceed the maximum operating temperature.

* For entering water temperatures below 7.5°C at start-up, contact Carrier. Please refer to options 28 and 42 for low-temperature applications (< -10°C).

** For low-temperature applications, where the leaving water temperature is below 5°C, a frost protection solution must be used. For low evaporator leaving water temperatures (< 5°C) please refer to option 6.

*** Maximum outside temperature: For transport and storage of the 30RB units the minimum and maximum allowable temperatures are -20°C and +48°C. It is recommended that these temperatures are used for transport by container.

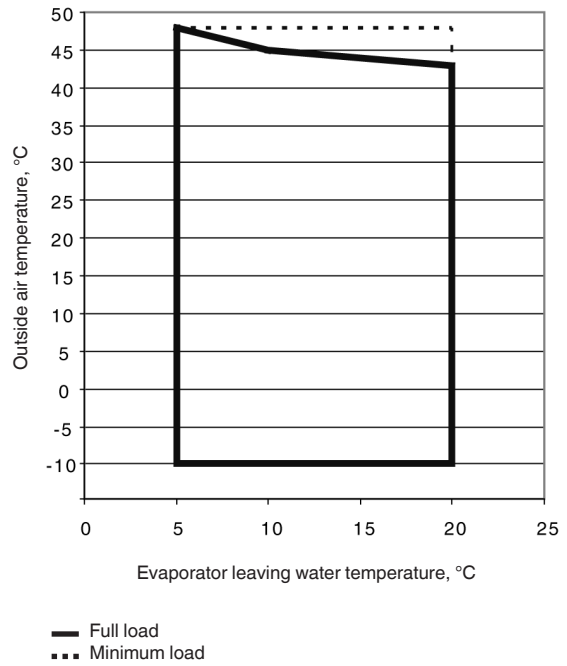

Dimensions/clearances

30RBS 039-080, units with and without hydronic module

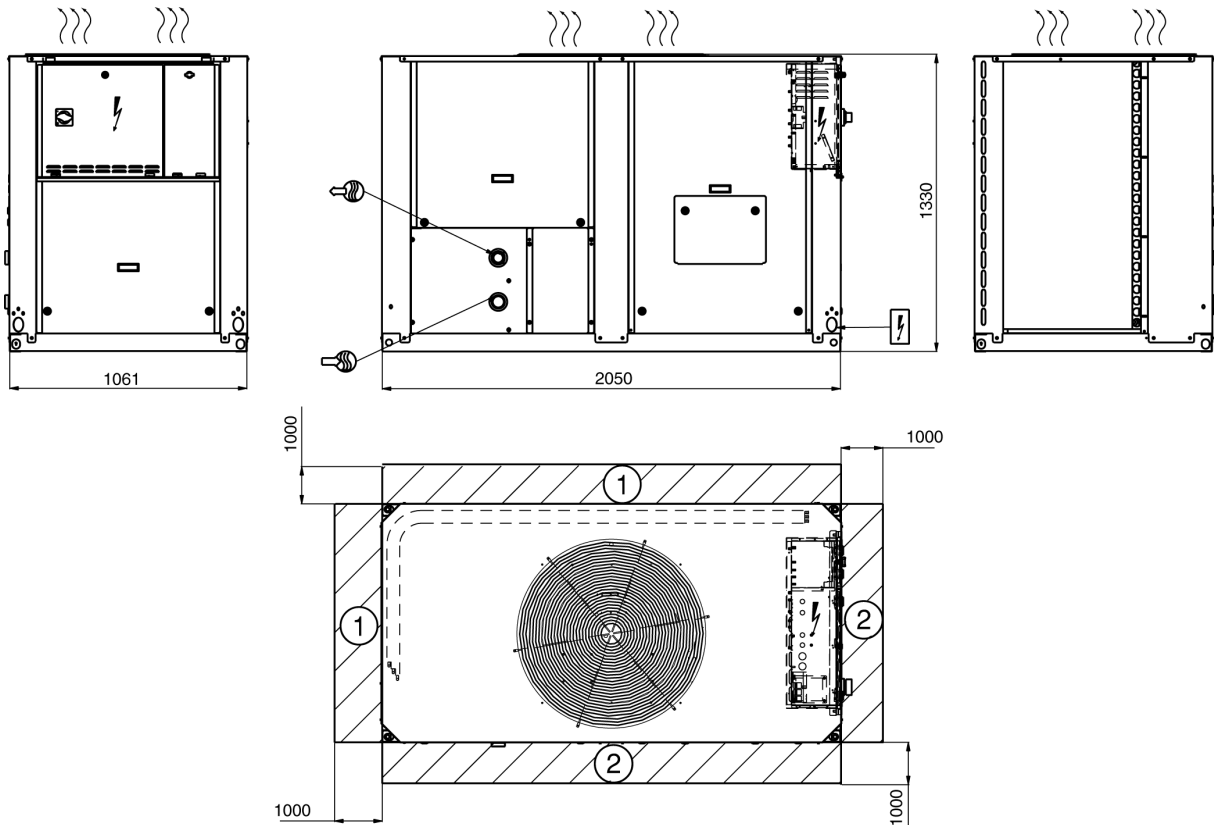





NOTES:

- A Non-certified drawings.
Refer to the certified dimensional drawings supplied with the unit or available on request, when designing an installation.
- For the location of fixing points, weight distribution and coordinates of the centre of gravity refer to the certified dimensional drawings.
- B In multiple-chiller installations (maximum four units), the side clearance between the units should be increased from 1000 to 2000 mm.
- C The height of the solid surface must not exceed 2 m.

Legend:

All dimensions are given in mm

-  Control box
-  Water inlet
-  Water outlet
- ① Required clearances for air entry
- ② Recommended space for maintenance
-  Air outlet, do not obstruct
-  Power supply inlet

Dimensions/clearances

30RBS 090-160, units with and without hydronic module

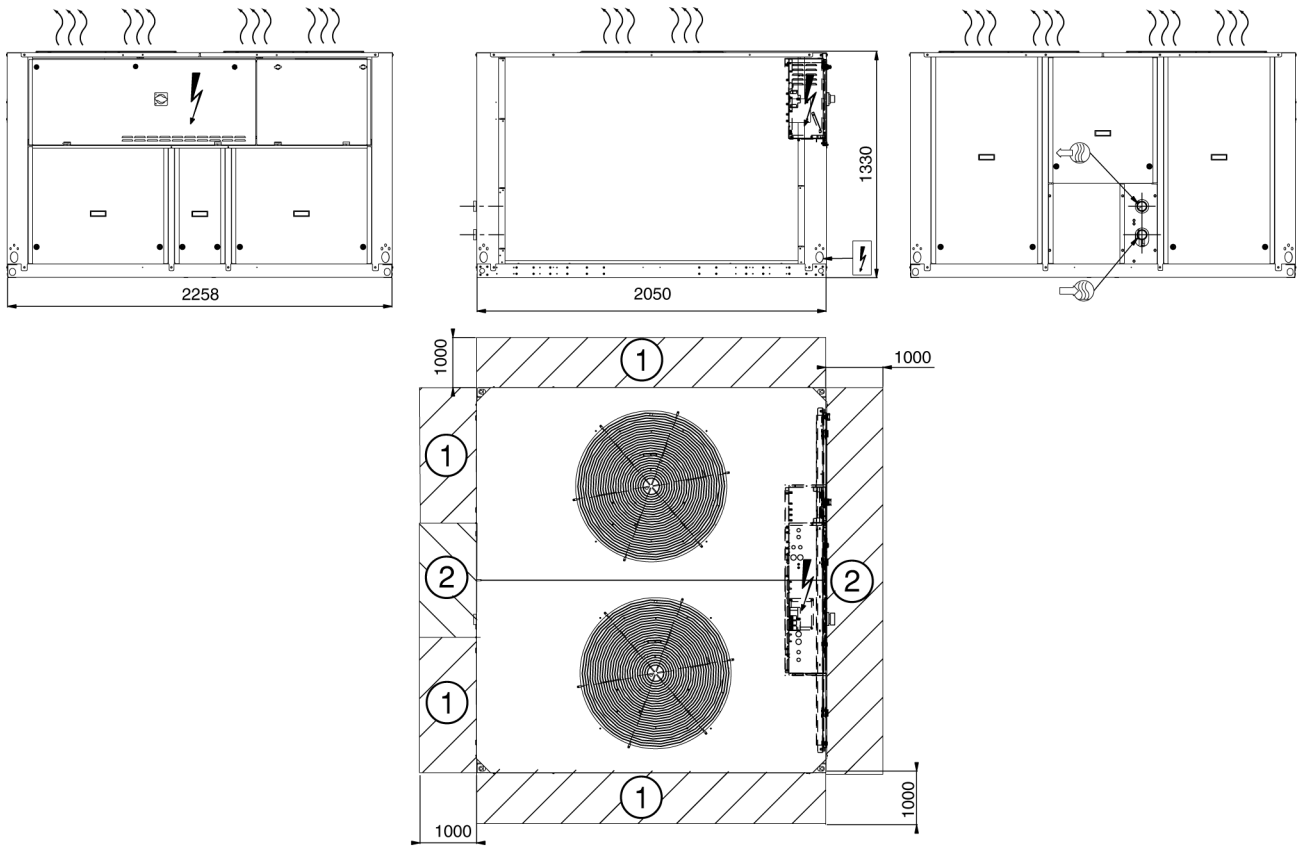





NOTES:

- A Non-certified drawings.
Refer to the certified dimensional drawings supplied with the unit or available on request, when designing an installation.
- For the location of fixing points, weight distribution and coordinates of the centre of gravity refer to the certified dimensional drawings.
- B In multiple-chiller installations (maximum four units), the side clearance between the units should be increased from 1000 to 2000 mm.
- C The height of the solid surface must not exceed 2 m.

Legend:

All dimensions are given in mm

-  Control box
-  Water inlet
-  Water outlet
- ① Required clearances for air entry
- ② Recommended space for maintenance
-  Air outlet, do not obstruct
-  Power supply inlet

Part load performances

With the rapid increase in energy costs and the care about environmental impacts of electricity production, the power consumption of air conditioning equipment has become an important topic. The energy efficiency of a liquid chiller at full load is rarely representative of the actual performance of the units, as on average a chiller works less than 5% of the time at full load.

The heat load of a building depends on many factors, such as the outside air temperature, the exposure to the sun and its occupation.

Consequently it is preferable to use the seasonal energy efficiency, calculated at several operating points that are representative for the unit utilisation.

ESEER (EUROVENT)

The ESEER (European seasonal energy efficiency ratio) permits evaluation of the average energy efficiency at part load, based on four operating conditions defined by Eurovent. The ESEER is the average value of energy efficiency ratios (EER) at different operating conditions, weighted by the operating time.

ESEER (European seasonal energy efficiency ratio)

Load %	Air temperature °C	Energy efficiency	Operating time, %
100	35	EER ₁	3
75	30	EER ₂	33
50	25	EER ₃	41
25	20	EER ₄	23

$$\text{ESEER} = \text{EER}_1 \times 3\% + \text{EER}_2 \times 33\% + \text{EER}_3 \times 41\% + \text{EER}_4 \times 23\%$$

Note: Constant leaving water temperature = 7°C

30RBS 039-160

Part load performances in accordance with Eurovent

30RBS	LOAD %	CAP kW	UNIT kW	EER kW/kW	ESEER kW/kW
039	100	39.4	13.7	2.88	4.04
	75	29.5	8.20	3.60	
	50	19.7	4.55	4.32	
	25	9.83	2.27	4.34	
045	100	44.6	16.1	2.77	4.09
	75	33.4	9.34	3.58	
	50	22.3	5.05	4.41	
	25	11.1	2.52	4.43	
050	100	51.4	18.8	2.74	4.07
	75	39.0	10.9	3.57	
	50	26.0	5.91	4.39	
	25	13.0	2.95	4.41	
060	100	58.4	21.2	2.76	4.06
	75	43.8	12.2	3.59	
	50	29.2	6.67	4.38	
	25	14.6	3.35	4.36	
070	100	66.7	24.4	2.74	4.04
	75	50.0	14.1	3.56	
	50	33.3	7.63	4.37	
	25	16.7	3.87	4.31	
080	100	78.4	30.1	2.61	4.04
	75	58.9	16.5	3.56	
	50	39.3	9.00	4.36	
	25	19.6	4.54	4.33	
090	100	89.4	31.8	2.81	4.22
	75	67.0	17.4	3.86	
	50	44.7	10.1	4.41	
	25	22.3	4.87	4.59	
100	100	99.9	35.9	2.78	4.20
	75	74.9	19.0	3.95	
	50	49.9	11.4	4.37	
	25	25.0	5.62	4.45	
120	100	117	43.2	2.71	4.12
	75	87.8	23.3	3.77	
	50	58.5	13.7	4.28	
	25	29.3	6.46	4.53	
140	100	134	49.1	2.74	4.14
	75	101	28.0	3.59	
	50	67.1	15.2	4.40	
	25	33.6	7.21	4.66	
160	100	157	57.9	2.71	4.13
	75	118	33.4	3.52	
	50	78.6	17.9	4.38	
	25	39.3	8.31	4.73	

Legend

- Load % - Unit heat load
- Cap kW - Cooling capacity
- Unit kW - Unit power input
- EER - Cooling capacity kW/unit power input kW

Hydronic module (option 116)

This module is equipped with pressure transducers to optimise unit operation at the hydronic level.

The hydronic module option reduces the installation time. The chiller is factory-equipped with the main hydronic components required for the installation: screen filter, water pump, expansion tank, safety valve and water pressure transducers.

The pressure transducers allow the Pro-Dialog+ control to:

- display the available pressure at the unit outlet and the static system pressure
- calculate the instantaneous flow rate, using an algorithm that integrates the unit characteristics
- integrate the system and water pump protection devices (lack of water, water pressure, water flow rate etc.)

Several water pump types are available: primary single or dual low-pressure pump or single or dual high-pressure pump.

An automatic pump start-up algorithm protects the heat exchanger and the hydronic module piping against frost down to -10°C outside temperature, if the evaporator frost protection option is installed. If necessary increased frost protection down to -20°C is possible by adding heaters to the hydronic module piping (see option 42).

The hydronic module option is integrated into the chiller without increasing its dimensions and saves the space normally used for the water pump.

Physical and electrical data

These are the same as for the standard unit except:

30RBS - units with hydronic module		039	045	050	060	070	080	090	100	120	140	160
Operating weight*												
Single pump		488	496	519	545	531	562	867	877	912	1021	1085
Dual pump	kg	514	522	545	571	557	588	912	922	960	1058	1122
Hydronic module												
Expansion tank volume	l	12.0	12.0	12.0	12.0	12.0	12.0	35.0	35.0	35.0	35.0	35.0
Maximum operating pressure	kPa	400	400	400	400	400	400	400	400	400	400	400
Water filter		Victaulic screen filter										
Low-pressure single and dual pumps												
Water pump		Pump, Victaulic screen filter, safety valve, expansion tank, purge valves (water and air), pressure sensors										
Shaft power input	kW	0.87	0.87	0.87	0.87	0.87	0.87	0.87	1.26	1.26	1.90	1.90
Power input**	kW	1.20	1.20	1.20	1.20	1.20	1.20	1.20	1.50	1.50	2.30	2.30
Nominal operating current draw	A	1.9	1.9	1.9	2.0	2.0	2.1	2.1	2.9	3.0	3.8	4.0
Maximum current draw at 400 V***	A	2.3	2.3	2.3	2.3	2.3	2.3	2.3	3.1	3.1	4.3	4.3
High-pressure single and dual pumps												
Water pump		Pump, Victaulic screen filter, safety valve, expansion tank, purge valves (water and air), pressure sensors										
Shaft power input	kW	1.90	1.90	1.90	1.90	1.90	1.90	1.90	1.90	2.56	2.56	2.56
Power input**	kW	2.30	2.30	2.30	2.30	2.30	2.30	2.30	2.30	3.00	3.00	3.00
Nominal operating current draw	A	3.1	3.2	3.2	3.3	3.3	3.4	3.5	3.6	5.0	5.1	5.3
Maximum current draw at 400 V***	A	4.3	4.3	4.3	4.3	4.3	4.3	4.3	4.3	5.8	5.8	5.8
Water connections (with hydronic module)												
		Victaulic										
Diameter	in	2	2	2	2	2	2	2	2	2	2	2
Outside diameter	mm	60.3	60.3	60.3	60.3	60.3	60.3	60.3	60.3	60.3	60.3	60.3

* Weight shown is a guideline only. To find out the unit refrigerant charge, please refer to the unit nameplate.

** To obtain the maximum power input of a unit with hydronic module, add the maximum unit power input to the pump power input (**).

*** To obtain the maximum current draw of a unit with hydronic module, add the maximum unit current draw to the pump current draw (***).

Typical hydronic circuit diagram

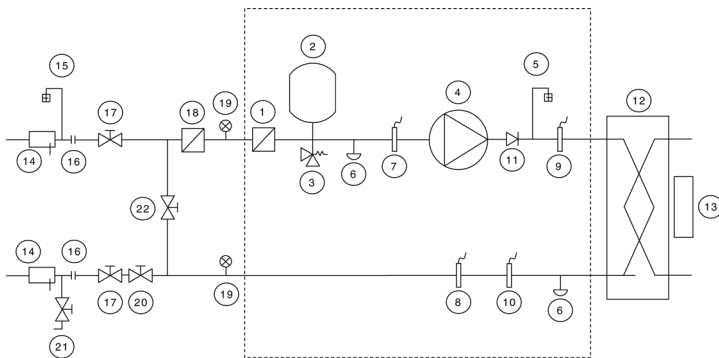

- 7 Pressure sensor
Note: Gives pump suction pressure information (see installation manual)
- 8 Temperature probe
Note: Gives heat exchanger leaving temperature information (see installation manual)
- 9 Temperature probe
Note: Gives heat exchanger entering temperature information (see installation manual)
- 10 Pressure sensor
Note: Gives unit leaving pressure information (see installation manual)
- 11 Check valve
Note: x 2 for a dual pump, not provided for a single pump
- 12 Plate heat exchanger
- 13 Evaporator frost protection heater

Installation components

- 14 Temperature probe well
- 15 Air vent
- 16 Flexible connection
- 17 Shut-off valve
- 18 Screen filter (obligatory for a unit without hydronic module)
- 19 Pressure gauge
- 20 Water flow control valve
Note: Not necessary for a hydronic module with a variable-speed pump
- 21 Charge valve
- 22 Frost protection bypass valve (when shut-off valves [17] are closed during winter)

--- Hydronic module (unit with hydronic module)

Legend

Components of the unit and hydronic module

- 1 Victaulic screen filter
- 2 Expansion tank
- 3 Safety valve
- 4 Available pressure pump
Note: x 1 for a single pump, x 2 for a dual pump
- 5 Air purge
- 6 Water drain valve
Note: A second valve is located on the heat exchanger leaving piping

Available static system pressure

Low-pressure pump

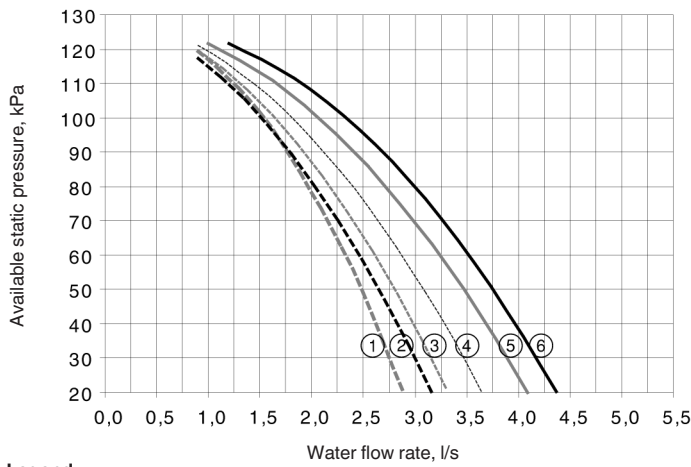

Legend

- 1. 30RBS 039
- 2. 30RBS 045
- 3. 30RBS 050
- 4. 30RBS 060
- 5. 30RBS 070
- 6. 30RBS 080

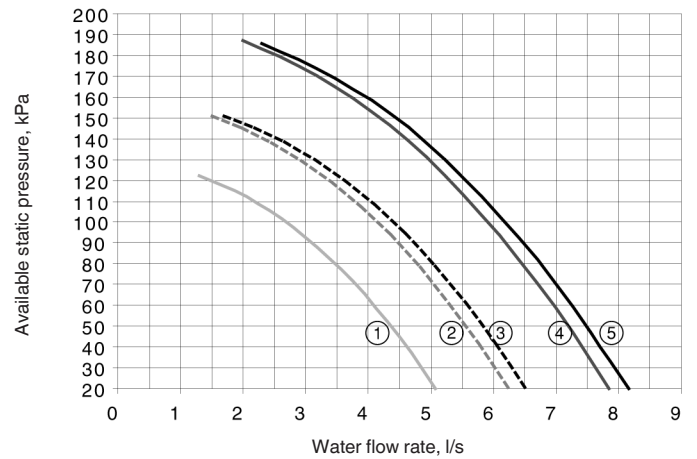

Legend

- 1. 30RBS 090
- 2. 30RBS 100
- 3. 30RBS 120
- 4. 30RBS 140
- 5. 30RBS 160

High-pressure pump

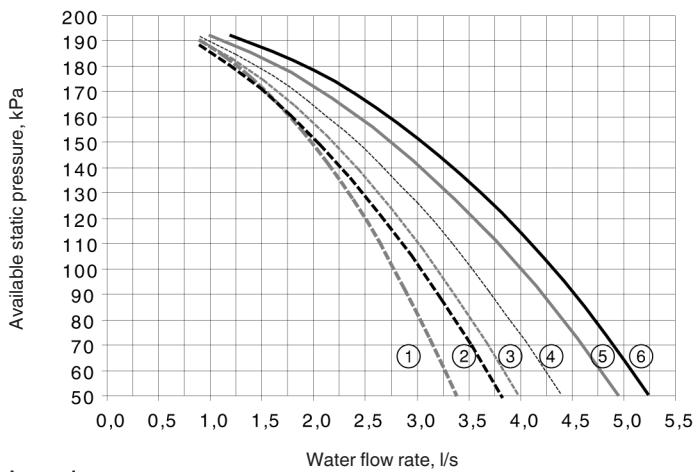

Legend

- 1. 30RBS 039
- 2. 30RBS 045
- 3. 30RBS 050
- 4. 30RBS 060
- 5. 30RBS 070
- 6. 30RBS 080

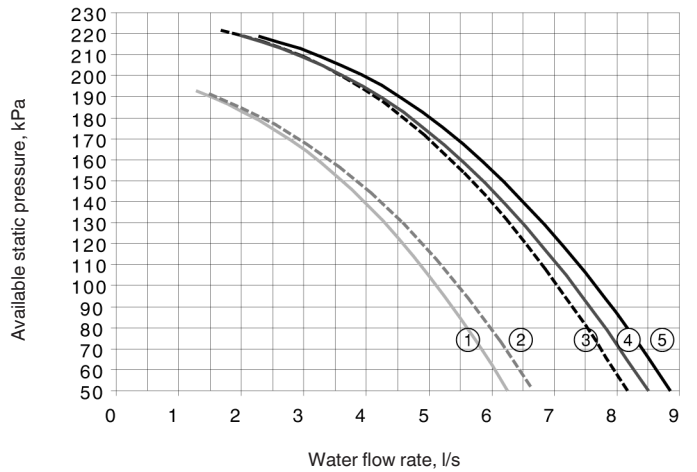

Legend

- 1. 30RBS 090
- 2. 30RBS 100
- 3. 30RBS 120
- 4. 30RBS 140
- 5. 30RBS 160

Variable water flow system (VWF)

Variable water flow is a hydronic control function package that permits control of the water flow rate.

The VWF not only ensures control at full load, a specific Carrier algorithm linked to an electronic frequency converter also continuously modulates the flow rate to minimise pump consumption at full load as well as part load.

The hydronic module includes pressure transducers that permit intelligent measurement of the water flow rate and real-time display on the Pro-Dialog+ interface. All adjustments can be made directly on the interface, speeding up start-up and maintenance.

As VWF acts directly on the pump, the system no longer requires the control valve at the chiller outlet. However, for applications with two-way valves a bypass system must be kept to guarantee the minimum flow rate.

Operating logic

■ Full-load set point

The flow rate control at full load uses the Pro-Dialog+ interface, reducing the pump speed. This first control saves energy that would normally be dissipated in the control valve. For example, if the pressure supplied by the pump is reduced by 20% the power consumption of the pump is reduced by the same ratio, compared to a traditional installation.

■ Operating mode at part load

Pro-Dialog+ includes two part-load operating modes:

- Constant outlet pressure control
- Constant delta T control.

1 – Constant unit outlet pressure control

The control continuously acts on the pump speed to ensure a constant outlet pressure.

This solution is suitable for installations with two-way valves. When these close, the water speed will accelerate in the system branches that are still open. For a fixed-speed pump this results in an unnecessary increase of the pressure at the pump outlet.

The outlet pressure control mode ensures that each circuit branch always has a uniform supply, without unnecessary energy waste.

In industrial processes such as plastic injection moulding, this solution ensures that each terminal unit has the correct pressure supply.

2 – Constant delta T control

The VWF algorithm maintains a constant delta T no matter what the chiller load, reducing the flow rate to the minimum.

This solution can be used for systems with two-way or three-way valves and achieves higher energy savings than the “Constant unit outlet pressure control” mode. It is suitable for the majority of comfort applications.

Energy saving simulation

On the following pages you will find a comparative study of full-load and part-load energy consumption with and without the use of VWF.

Example using model 30RB 100

- System with delta T = 5 K
- Internal unit pressure drops = 52 kPa
- The circuit includes 40 terminal units equipped with valves
- Pressure drop, terminal units with valves = 50 kPa
- Average pressure drop in the distribution system = 50 kPa
- Required system pressure = 100 kPa
- Part load = 25% of the valves closed

■ Full load consumption

1 – Fixed-speed pump (without VWF)

In order to settle the system at a correct delta T and flow rate at full load, the control valve at the chiller outlet must be adjusted to obtain a pressure drop of 32 kPa after the unit. The impact on the energy consumption will not be measurable.

- A = Ideal operating point
- B = Flow rate/pressure without control
- C = Flow rate/pressure after control

Curves, pump pressure head and power input/water flow rate (fixed speed)

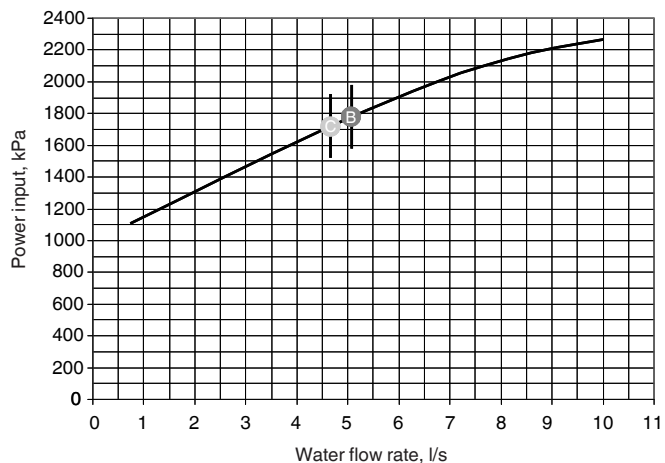
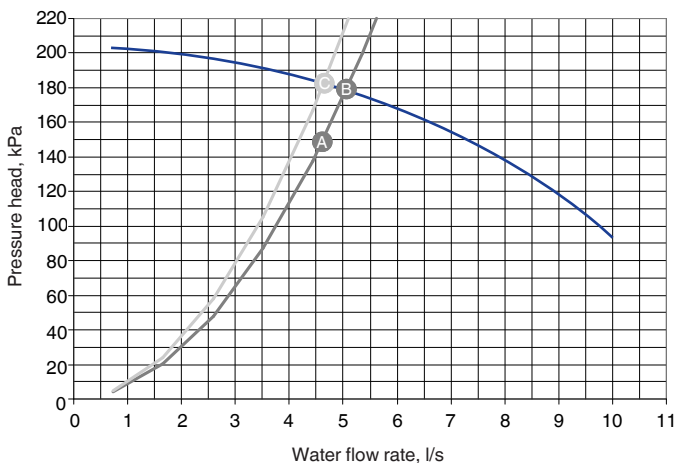

2 – VWF system

The flow rate control uses the Pro-Dialog+ interface to modify the rotational speed of the pump. The reduction in consumption is more significant (20%) as both flow rate and pressure at the pump outlet are affected.

Curves, pump pressure head and power input/water flow rate (with VWF)

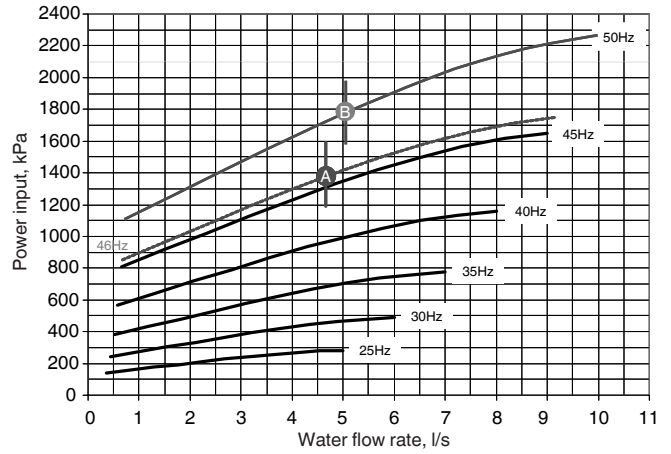
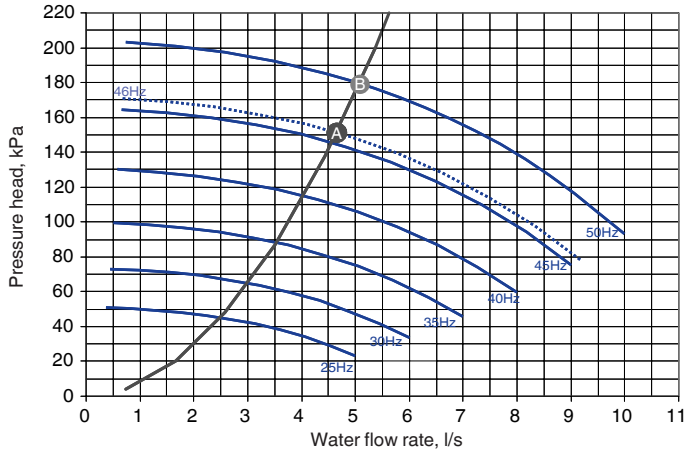

■ Consumption at part load and 25% of the valves closed

1 – Fixed-speed pump (without VWF)

Closing the two-way valves will modify the system pressure which will in turn affect the flow rate, but will only reduce the energy consumption of the pump by 3%.

With a three-way valve the variation will not be measurable.

- C = Flow rate/pressure after control
- D = Flow rate/pressure with 25% of the two-way valves closed.

Curves, pump pressure head and power input/water flow rate (fixed speed)

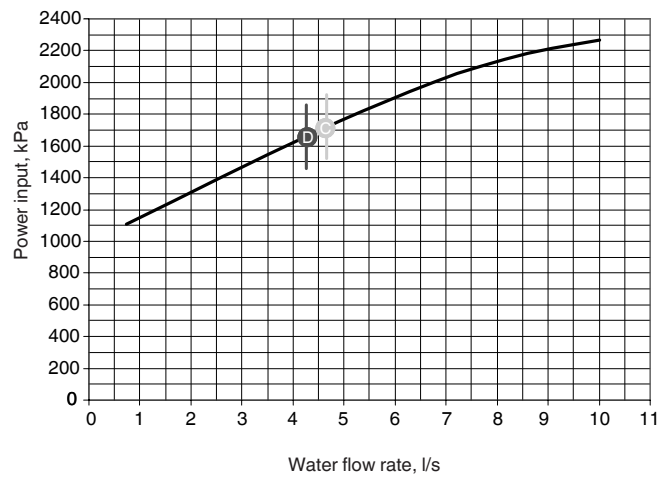
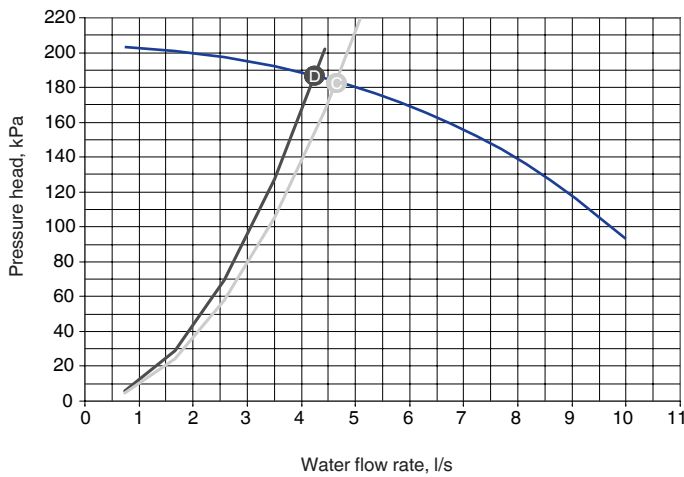

2 – VWF system

Constant unit outlet pressure control mode

- A = Flow rate/pressure at full load
- A' = Flow rate/pressure at part load with two-way valves

Note: Three-way valves have no or little impact on the flow rate and the pressure.

Curves, pressure head and power input/water flow rate, pumps with VWF and constant pressure

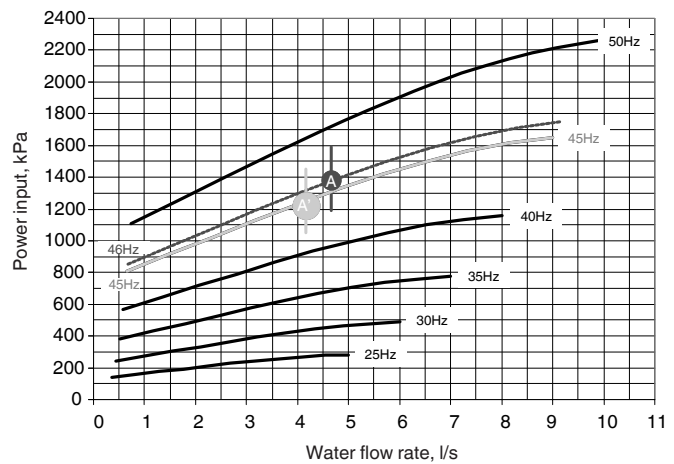
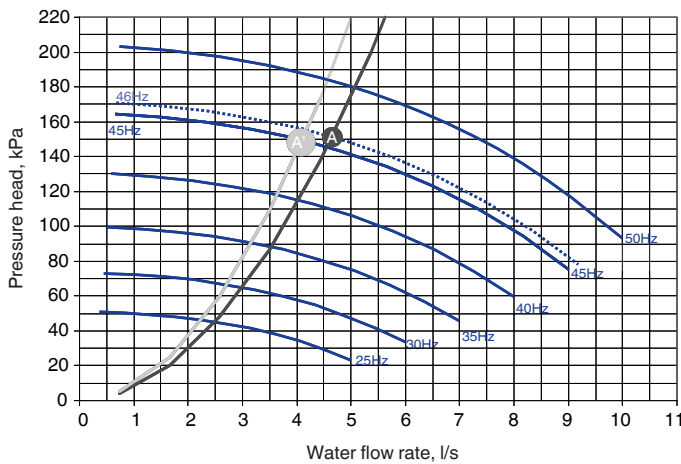

Constant delta T control mode

- A = Flow rate/pressure at full load
- A'' = Flow rate/pressure at part load with three-way valves
- A''' = Flow rate/pressure at part load with two-way valves

This solution allows the most significant energy savings, as the VWF continuously acts not only on the flow rate, but also on the pressure, both with two-way and three-way valves.

Curves, pressure head and power input/water flow rate, pumps with VWF and constant delta T

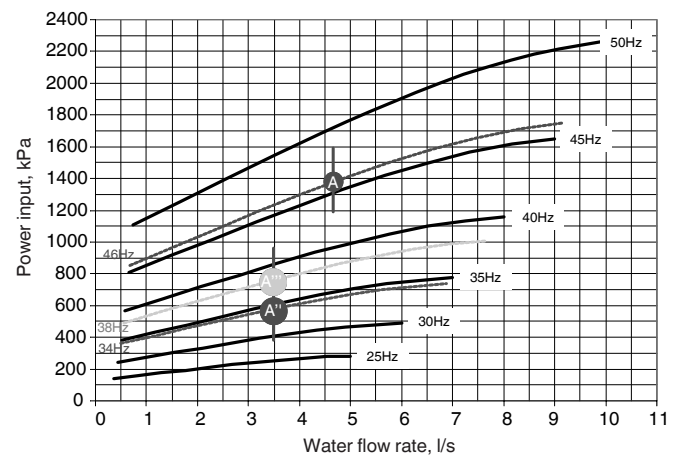
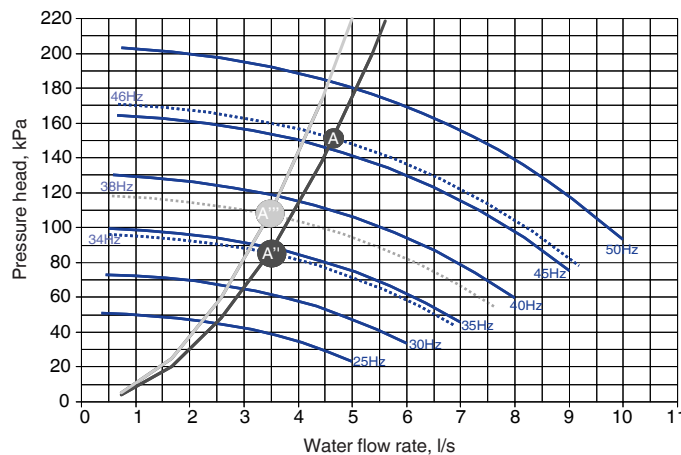

Energy consumption for this example

30RBS system with 2-way valves	Full load	Part load
Fixed speed	1720 W (100%)	1660 W (97%)
VWF system		
Pressure control	1380 W (80%)	1250 W (73%)
Delta T control	1380 W (80%)	760 W (44%)

30RBS system with 3-way valves	Full load	Part load
Fixed speed	1720 W (100%)	1720 W (100%)
VWF system		
Pressure control	1380 W (80%)	1380 W (80%)
Delta T control	1380 W (80%)	580 W (34%)

Carrier is participating in the Eurovent Certification Programme for liquid chilling packages. Products are as listed in the Eurovent Directory of Certified Products or on the Internet site www.eurovent-certification.com.

This programme covers air-cooled chillers up to 600 kW and water-cooled chillers up to 1500 kW.



Environmental Management System Approval



Order No.: 13461-20.04.2009. Supersedes order No.: New.
Manufacturer reserves the right to change any product specifications without notice.

Manufactured by: Carrier SCS, Montluel, France.
Printed in the Netherlands.